

Wood Ramp Design: How to Add a Ramp

Abstract: This booklet was designed to help individuals avoid costly - and sometimes dangerous - mistakes in the design and construction of ramps. In simple language, it touches on entrance options, design and materials choices, costs, and compliance with codes.

First Author: North Carolina State University Center for Universal Design

Keywords: construction details; construction details; design considerations; home modifications

Discipline: home renovation; accessibility; construction

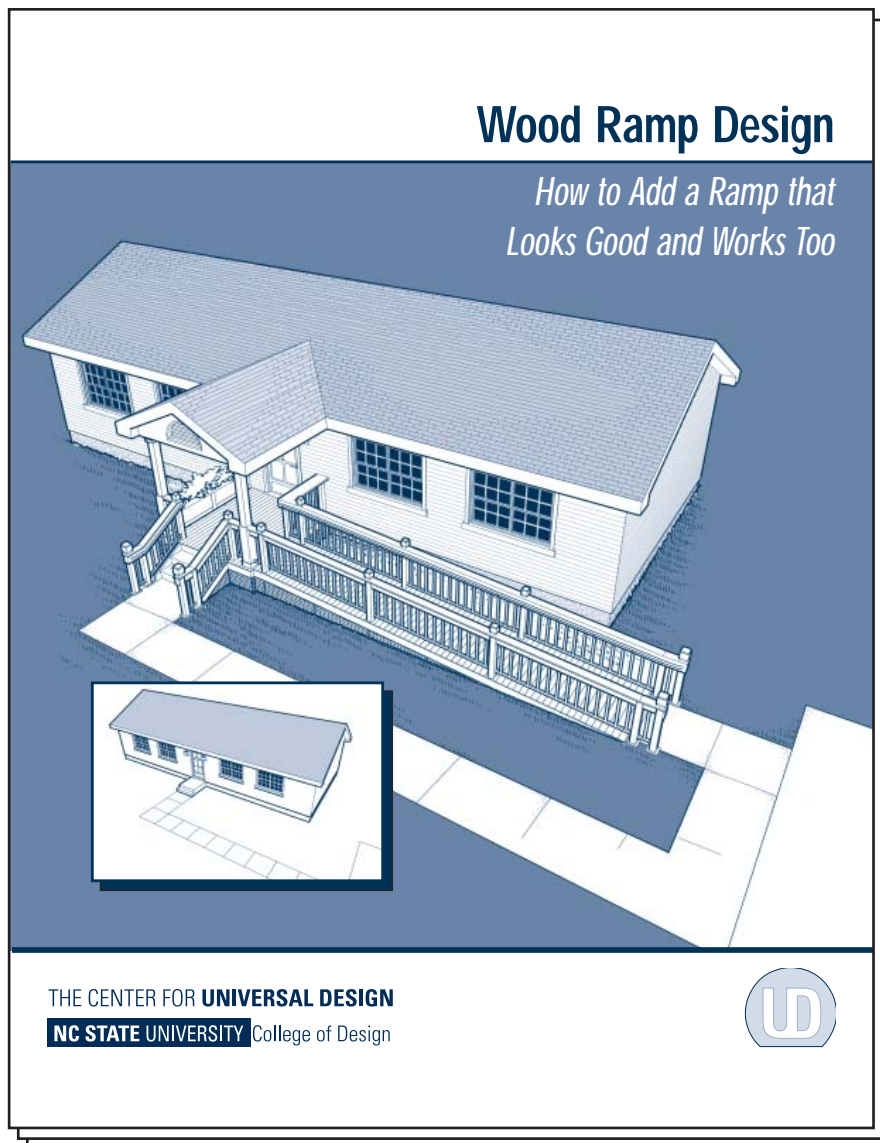

This information is advisory and the guidance provided is not legally binding. Refer to specific codes and regulations within your jurisdictions. No guarantee is offered or implied for the completeness of the information provided.

Wood Ramp Design

*How to Add a Ramp that
Looks Good and Works Too*

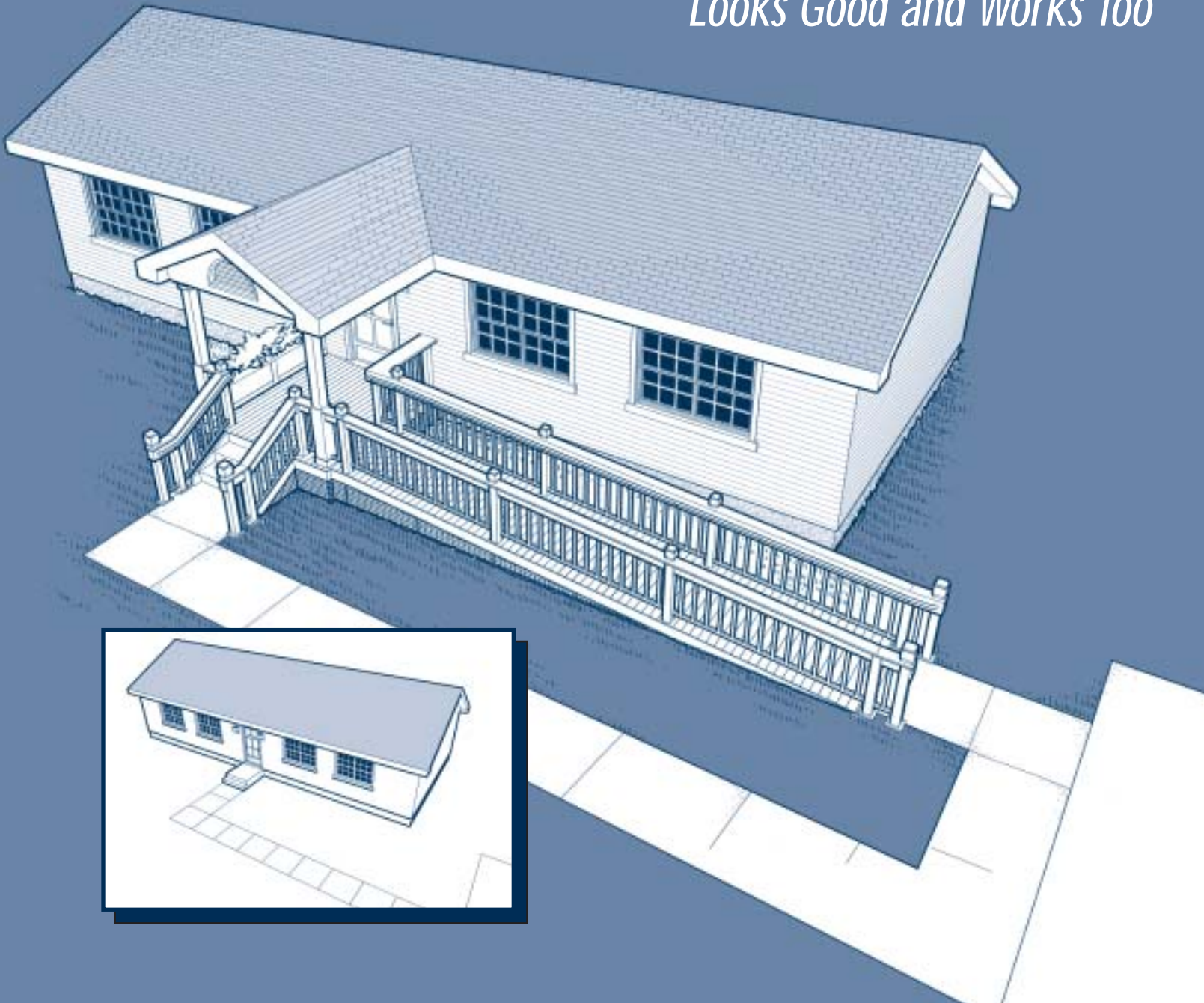

Welcome

Home modifications—including ramps, adapted living spaces, and assistive technology—make it possible for individuals with disabilities to navigate their environments confidently and safely. Home modifications also allow individuals who develop mobility limitations and other disabilities to remain in their own homes rather than having to leave because of accessibility problems. In addition, they also make communities more inclusive, as accessible homes are able to accommodate people with disabilities who visit. Unfortunately, the majority of programs that fund disability-related services and supports in Delaware—including private insurance, Medicaid, and Medicare—fail to include home modifications as covered benefits. As a result, many individuals and families shoulder the responsibility for home modifications on their own: designing the project, finding a contractor or volunteer help for construction, and paying for the project with their own funds.

This booklet was designed to help Delawareans avoid costly—and sometimes dangerous—mistakes in the design and construction of ramps. In simple language, it touches on entrance options, design and materials choices, costs, and compliance with codes. This booklet is one product of a larger effort funded by a federal grant from the Centers for Medicare and Medicaid Services to Delaware Health and Social Services designed to help Delaware residents with disabilities access the equipment and services that they need to live safely and comfortably in the community. For more information, contact the Delaware Assistive Technology Initiative at (302) 651-6790 (voice), (302) 651-6794 (TDD), or access its comprehensive website at www.dati.org.

Beth Mineo Mollica, Ph.D.
Director
Delaware Assistive Technology Initiative

Joseph B. Keyes, Ph.D.
Project Coordinator
Assistive Technology Grant
Delaware Health & Social Services

Wood Ramp Design

Stairs can make entering or exiting a home difficult for many people. For those with disabilities using a conventionally constructed home entrance with stairs can be hard or impossible. For these households, it may be necessary to construct a “stepless” entrance as an alternative. Ramps are an option that can often create safer and easier entrances for a household member or a visiting friend or relative with mobility problems. With growing numbers of people with disabilities and swelling ranks of seniors, more and more households are grappling with home entrance problems.

Benefiting from an added ramp are those who use wheelchairs, walkers, and canes as well as those who may not use equipment but whose balance, strength, or stamina make stair climbing difficult or unsafe. Unfortunately, few know about ramp design and materials for single-family residences, and too few publications can help. As a result one can find many unattractive ramps that detract from a home’s appearance and discourage others from adding these useful additions. In other instances, ramps have been built unsafely with steep inclines, slippery surfaces, or inadequate railings.

This book is a starting point for remodelers, experienced do-it-yourselfers, volunteer groups, carpenters and others who are considering the design and construction of wood ramps for single-family residences. This guide will help you design and build ramps that are smart, safe, and attractive. However, this publication is not intended for use as a construction manual. Please rely on experienced carpenters or builders for construction expertise. All applicable state and local codes should be observed.

Refer to the resource list at the end of this publication for detailed information about the following related topics that are not discussed in this publication.

- **Accessible site and entrances**
- **Construction details**
- **New accessible construction guidelines**
- **Commercial or public accommodations**
- **Remodeling rental units**
- **Compliance with federal, national or state accessibility guidelines, codes, or regulations**
- **Temporary ramps**

Table of Contents

Entrance Options	2
Slope and Configuration	3
Aesthetics	4
Design Details	5
Costs	10
Materials	10
Code Compliance	11
Resource Publications	12

Entrance Options

Ramps are one of the easiest, and sometimes the best, of several stepless entrance options that include vertical platform lifts and landscaped entrances. Each is appropriate for a particular combination of resources, heights, and site conditions. You must carefully weigh the advantages and disadvantages for each option. Below are outlines of each option.

Ramps

For many, ramps are the most familiar home accessibility modification. They can be built quickly by carpenters or handymen and can be inexpensive, especially when using volunteer groups or donated materials. Although ramps make a big difference in the lives of those who use them, they may have drawbacks as well. Ramps accommodating rises above 30" require a lot of construction, are very long, take up a lot of space, and can be quite expensive. Ramps add maintenance for the homeowner, too. Leaf, snow and ice removal, painting, and periodic repairs all take time and resources (see cost information on page 10). Ramps can also have a negative impact on the appearance of a home, particularly if constructed in an incompatible style.

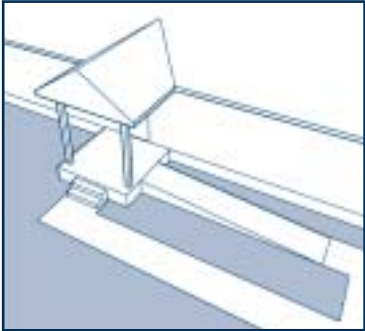

Ramps
work best for heights up to 30"

Lifts

Taking up less than 30 square feet of space, an electrically operated vertical platform wheelchair lift can avoid the space problems of long ramps. Where possible, locate lifts under cover to reduce snow and ice accumulation in the winter. In sites prone to flooding, potential water damage to mechanical components must be taken into account. The cost of lifts includes a concrete slab, electrical power and related remodeling expenses that can range between \$5,000-\$15,000.

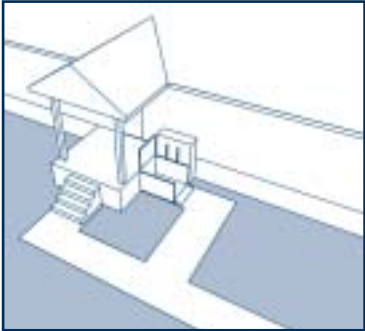

Lifts
space saving option for heights over 30"

Site Grading and Landscaping

Site conditions may offer an opportunity to use landscaped earth pathways for a more natural and blended solution than other options. This approach may include a retaining wall, an earth berm, and sometimes a bridge to an entrance. A safe path with a gentle slope of 1:20 or less can be built without railings (unless there are abrupt drop-offs on either side or users need them), thereby avoiding the cost and intrusive appearance of the railing. Landscaped options are often more expensive than an equivalent ramped solution, but can have a longer lifespan and need less maintenance.

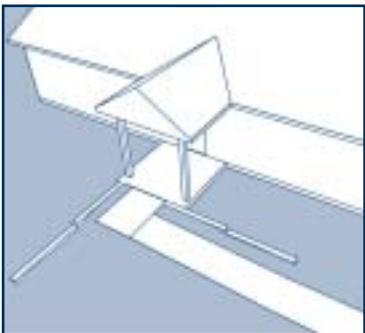

Earth Berms and Regrading
depending on site conditions, can work for all heights

Temporary Ramps

Not everyone requires the long-term use of a ramp. Needs may be temporary or families may plan to move. In these situations the construction of re-usable ramps may be appropriate, allowing the re-use of costly materials. Re-usable ramps are usually built in sections and placed on pads on the ground with screws or bolts joining the components. This allows the ramp to be easily dismantled and installed at another home. Prefabricated metal ramps are also available. While these kinds of ramps may be more expensive than wood ones, they do offer long term durability and most components can be reused. (See Reference Publication, *How to Build Ramps for Home Accessibility*)

Slope and Configuration

Traditional design guidelines call for a maximum ramp slope of 1:12. In other words, you will need twelve inches of ramp for every inch of rise. In fact, many people struggle while using 1:12 sloped ramps because they find it difficult to wheel up or maintain walking balance. For this reason a slope of 1:16 slope is recommended where possible. Limit continuous runs of ramp to avoid long and tiring climbs. Periodic level areas between slopes will allow for resting and maneuvering.

Try to fit ramps into compact and cost effective shapes. In addition to straight ramps, ramps can be L-shaped, switch back, and U-shaped. Limitations on space and constrained starting and ending points may require changes of direction. Provide level platforms at all turns to allow easy and safe maneuvering.

Warning! If you find yourself planning a ramp over 30' long, make sure that you have considered other access options such as lifts.

Ramp Configurations

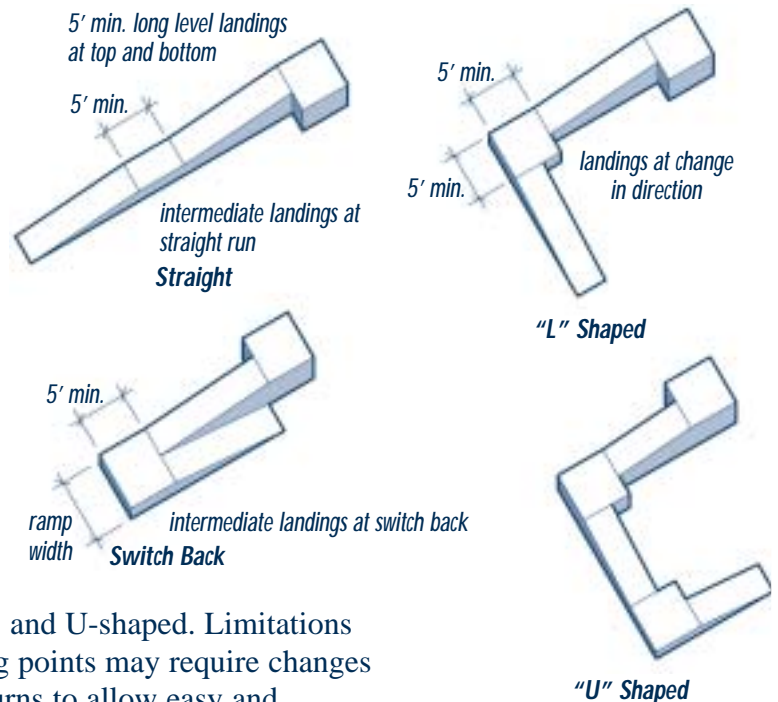

Maximum Ramp Slopes Between Landings

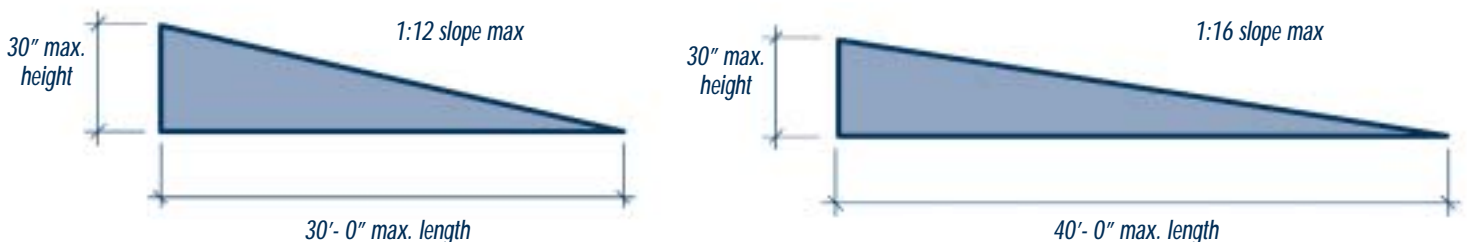

Aesthetics

Unattractive looking ramps detract from a home's appearance, may reduce its market appeal, and may discourage others from considering needed ramps. In some instances, a household may be forced to pay for the removal of an ugly and/or poorly constructed ramp to sell a home. There are creative ways to produce a ramp that will blend into the overall design of a home on its site.

Match

Matching a home's style and construction materials can help a ramp blend into the surroundings. Match the baluster and rail style of the existing porch. A variety of square or turned post and baluster styles are available at many home centers.

Soften

Add shrubbery and other plantings around the ramp that are compatible with the vegetation around the rest of the home.

Scale

Balance the size and appearance of ramps by using suitably scaled materials that are compatible with existing trim styles and consistent with local building code requirements. In most cases use vertical supports no larger than 4" x 4", stringers no larger than 2" x 8", and decking no larger than 2" x 6". In addition, most ramps in single-family residential settings need no more than 36" to 42" of clear space between the handrails. These features help distinguish residential ramps from their utilitarian cousins on commercial and public buildings.

Minimize

Route the ramp in a way that will result in the shortest length possible by taking advantage of high points on the existing site grade. Use the rise in elevation of the ground to cut ramp length and massing. A 20' long ramp built on level ground can become a 12' long ramp if you are able to take advantage of 8" of rise on the site. Consider using a back or side entrance to take advantage of beneficial slopes.

Combine

Use the ramp as an opportunity to add a larger deck or sitting area near the doorway. This will help the ramp become a part of a larger appealing project.

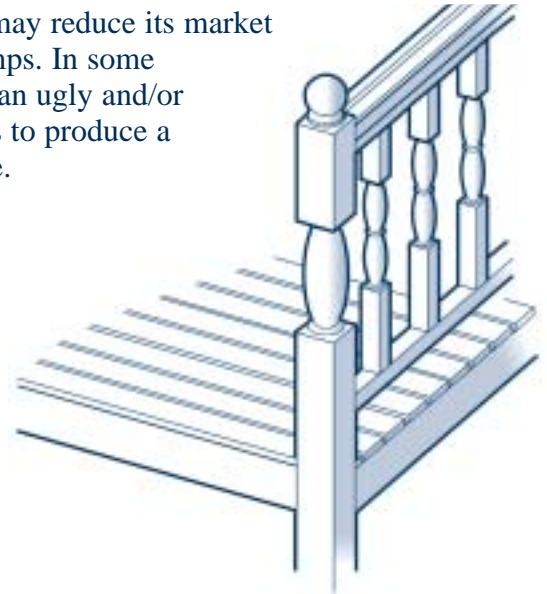

Ramp Picket, Baluster and Rail Style Match Those of Existing Porch and/or Deck



Plantings Minimize and Soften the Visual Impact of Ramps

Separate

A long imposing ramp run can be reduced by separating it into two or three sections, perhaps by connecting two or three decks, creating interesting and functional areas that can be used for sitting or plants.

Finishes

Use pressure treated wood for most of the wood materials in ramp construction. While ramps are usable immediately after construction is completed, wait three to six months for the wood to dry before any finish is applied. Always apply a finish that matches or complements the home's exterior. Finishes may help decking surfaces be less prone to slipping and sliding hazards if slip resistant additives are used (See Slip Resistance on page 10). Whether to use paint or stain is largely a personal choice; however, the use of stains may limit peeling and help to reduce maintenance requirements.

Design Details

Most porches or entry stairs are one step below the first floor. All long-term entry solutions must eliminate this step and create a level entry. Mini-ramp options, which create short, steep ramps to get over steps, should be avoided for all but the most temporary solutions.

Many existing porches are too small for easy maneuvering or lack sufficient latch-side clearance. This requires that a replacement porch or a new porch be built over the existing porch or stairs.

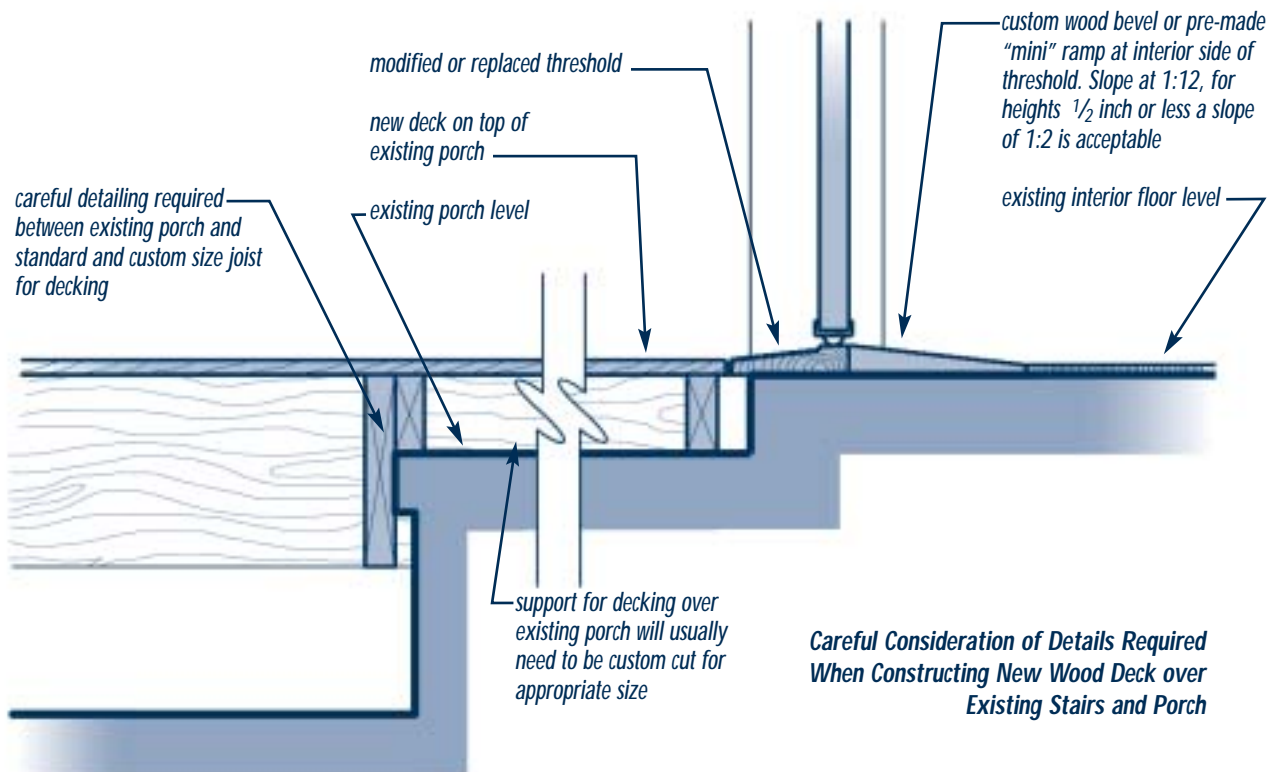

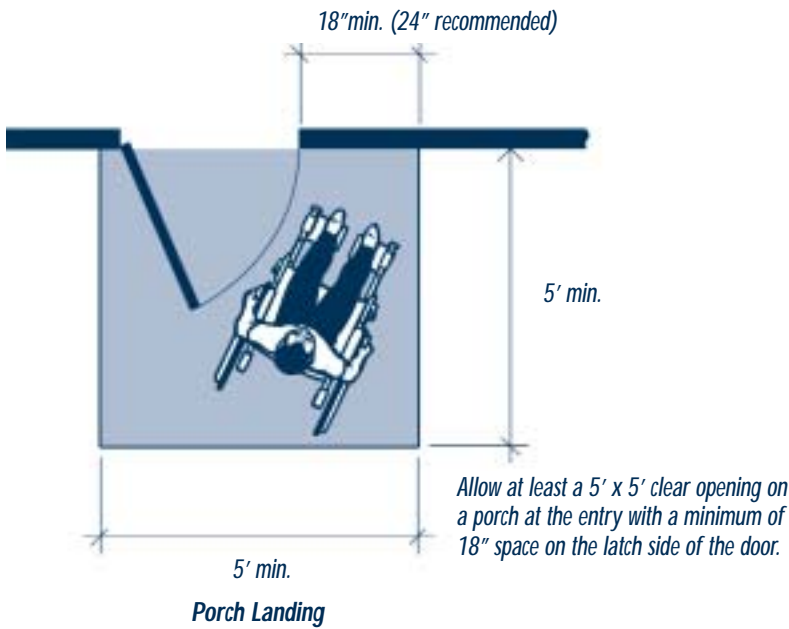

Adding a porch roof will reduce water problems at the door and will protect users from inclement weather while unlocking and maneuvering around entry doors.

An attractive planter acts as a guardrail and provides easy-to-reach gardening.

Ramps may not be for everyone. Stairs are safer for many who have balance trouble. When adding ramps and making changes in porches and entrances, retain or add a well-built stairway.

Installing a package shelf frees hands for opening doors.

Improve the appearance of ramps by adding decorative treatments such as lattice that extends to the ground and balusters that match the style of the house.

Many existing porches are too small for maneuvering and are 4" to 7" below the level of the first floor. All accessible entries should be level with the first floor.

Steps that lack handrails don't provide the stability and support that many need and can be dangerous.

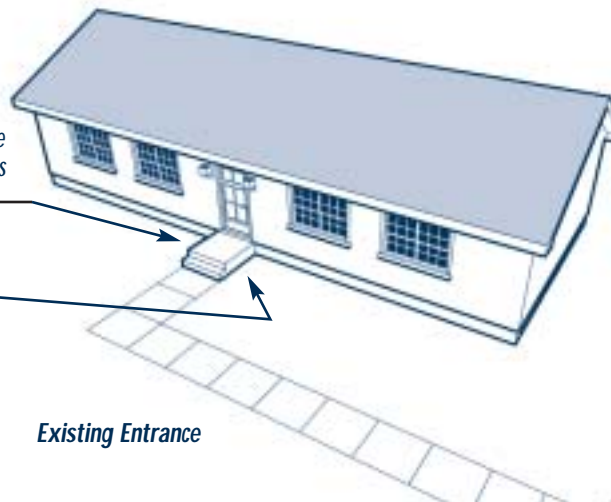
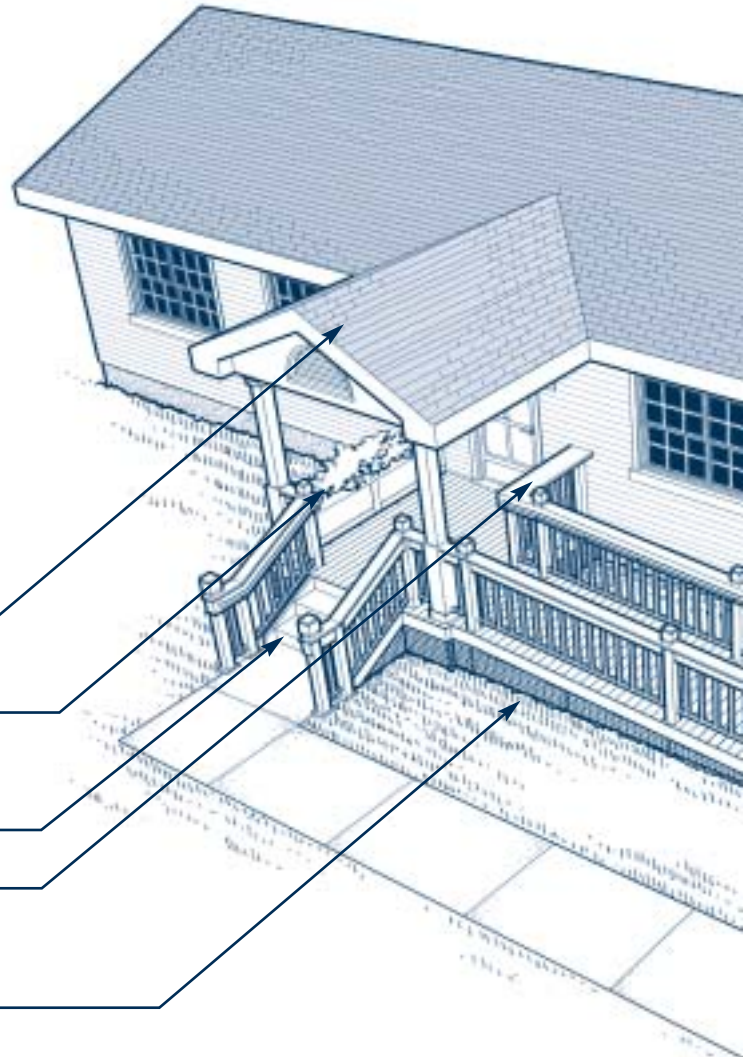

House with Added Ramp and Remodeled Entrance

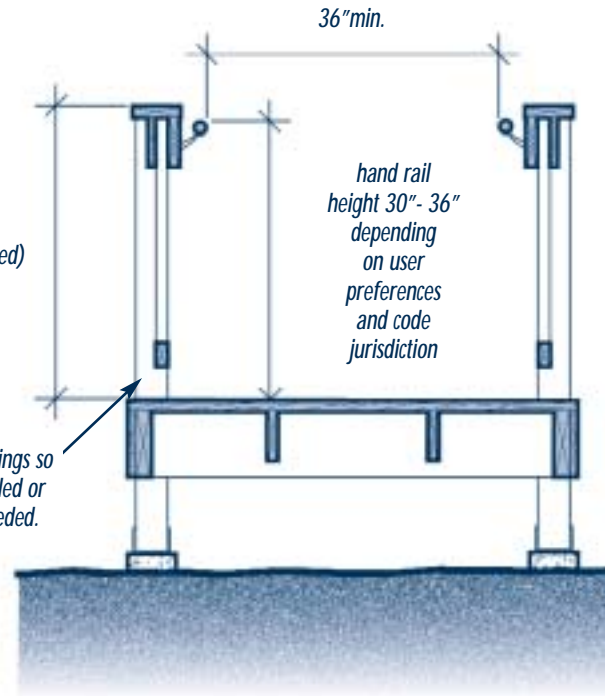
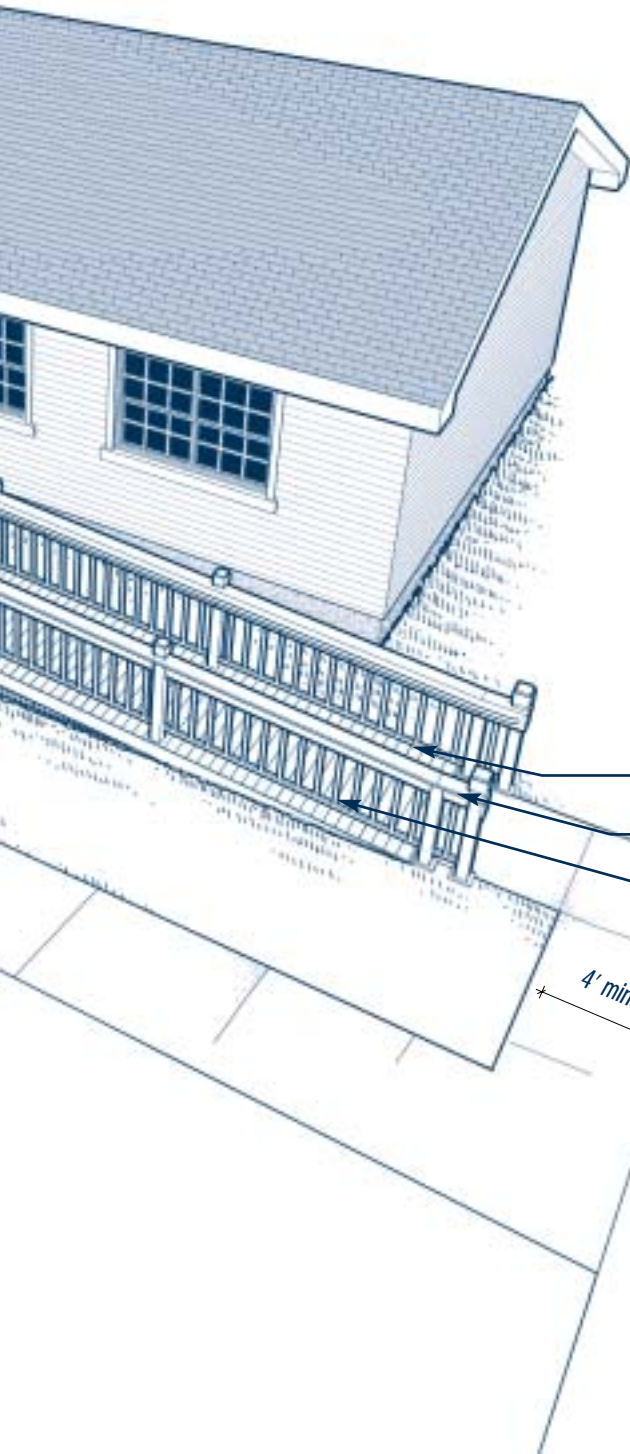

Section at Ramp

Provide a space below the railings so snow and leaves can be shoveled or brushed off. Add midrail if needed.

All decking should be installed perpendicular to the path of travel with at least 1/8" gaps between boards to allow for drainage. These gaps also offer traction for wheels of mobility devices and shoes.

Handrails that extend beyond the top and bottom of stairs and ramps provide greater stability and safety for many.

The combination of closely spaced pickets and a lower rail provides protection against drop offs.

If modifying a walk, consider creating a level "landing" pad for those who must transfer out of their vehicles into mobility devices or deploy lifts. These level areas are particularly useful when parking spaces are dirt or gravel.

Location

The placement of a ramp will usually depend upon the location of a home's entrance, the location of parking, and the slope of the site. Pick a location that results in the shortest ramp possible. Level sites aren't always best. A 20' long ramp on level ground can become a 12' long ramp if you are able to take advantage of 8" of rise on the site. Consider using a back or side entrance to take advantage of beneficial slopes. You could also build a bridge across a gully or depression to a porch. Occasionally, tight spaces at existing entrances may require you to create a new entrance by turning a window into a doorway.

Elements of a Ramp

Guardrails

Guardrails on decks (check your local code to determine required guardrail height) will generally need to be at least 36" high. Ramps with slopes steeper than 1:20 will usually need to have guardrails, too.

Handrails

Properly shaped and located handrails that provide safety and stability are an essential part of all well built stairs and ramps. Handrails should be located between 30" and 36" above the step or ramp surface. Some individuals who use wheelchairs may need a lower rail added at 24" to aid in pulling themselves up a ramp. Install handrails on both sides of ramps and stairs with an easy-to-grip round or oval shape that is 1 1/4" to 1 1/2" in diameter. Handrails that extend horizontally beyond the top and bottom of stairs and ramps allow greater stability by allowing users to continue to grip the rail just before or after they have moved onto or off the stepped or inclined surface.

Preferred Handrail Shapes

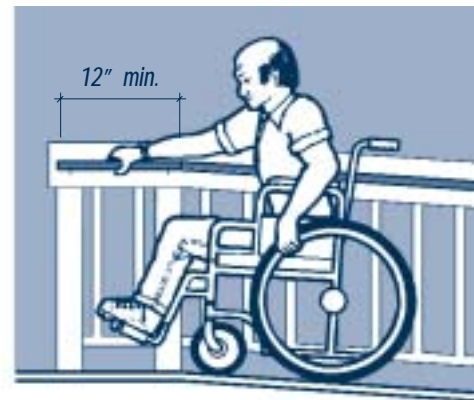
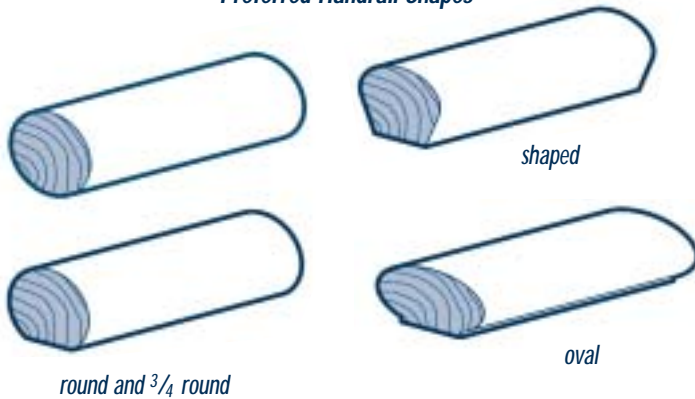

Handrail Extensions are Helpful to Many People

1 1/2" clearance allows enough space for fingers and knuckles but narrow enough to prevent an arm from passing through and getting caught.

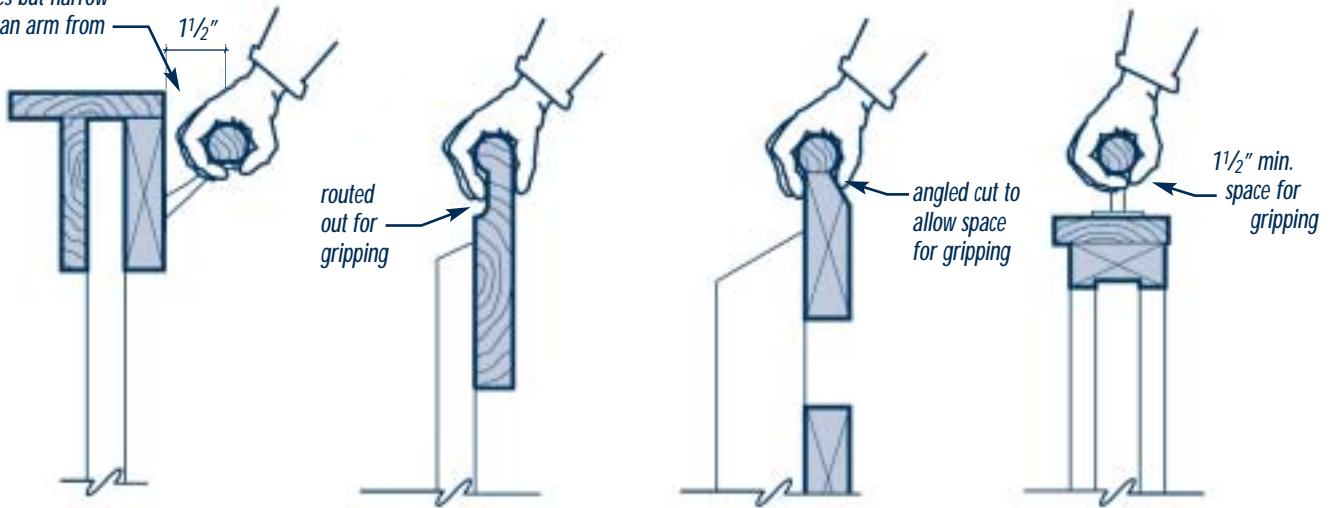

Side Mounted Handrail

Shaped Handrail as Integral Part of Guardrail

3/4 Round Handrail Attached to Top of Guardrail

Top Mounted Handrail

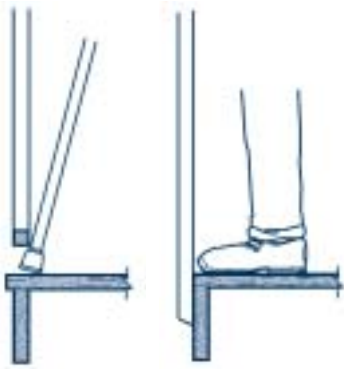

lower rails

pickets that extend below ramp surface

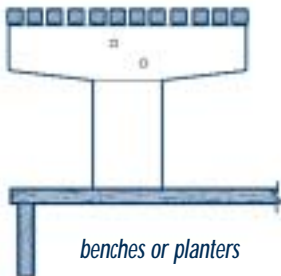

benches or planters

Balusters

Balusters are the vertical posts and pickets that support a guardrail or handrail. Remember that local or state codes may require certain baluster spacing on porches, decks, and ramps. Balusters with spacing between 4" and 9" are dangerous for children. Ramps and decks that are less than 18" above surrounding grade can have balusters with spacing less than 4" apart or more than 9" apart. Decks, porches, or ramps that extend 18" above surrounding grade need to limit the baluster spacing to less than 5". (Check your local building code.)

Curbs

Ramps that don't have narrowly spaced vertical pickets will need to have a curb near the bottom edge to prevent feet, crutch tips, or front wheelchair wheels from slipping off. Curbs can interfere with maintenance by hindering the removal of leaves or snow from the travel surface.

Stairs

When adding a ramp, keep or rebuild stairways for those for whom stairs are a convenience. Avoid building stairs with nosings; instead build inclined risers at an angle of

75° to decrease tripping hazards. Open risers also invite toes, feet, or crutch tips to get caught. Avoid building stairs with open risers and add risers to existing stairs without them.

Consider building stairs with treads wider than those typical of residential construction. Stairs with treads 11" deep and risers 7" high will ease stair climbing for many people. Other people who walk with mobility impairments may benefit from steps with even deeper treads and shallower risers than this. For instance, a person using a walker may benefit from a tread as wide as 24". Consider this option carefully as others without walking disabilities may find these awkward to use.

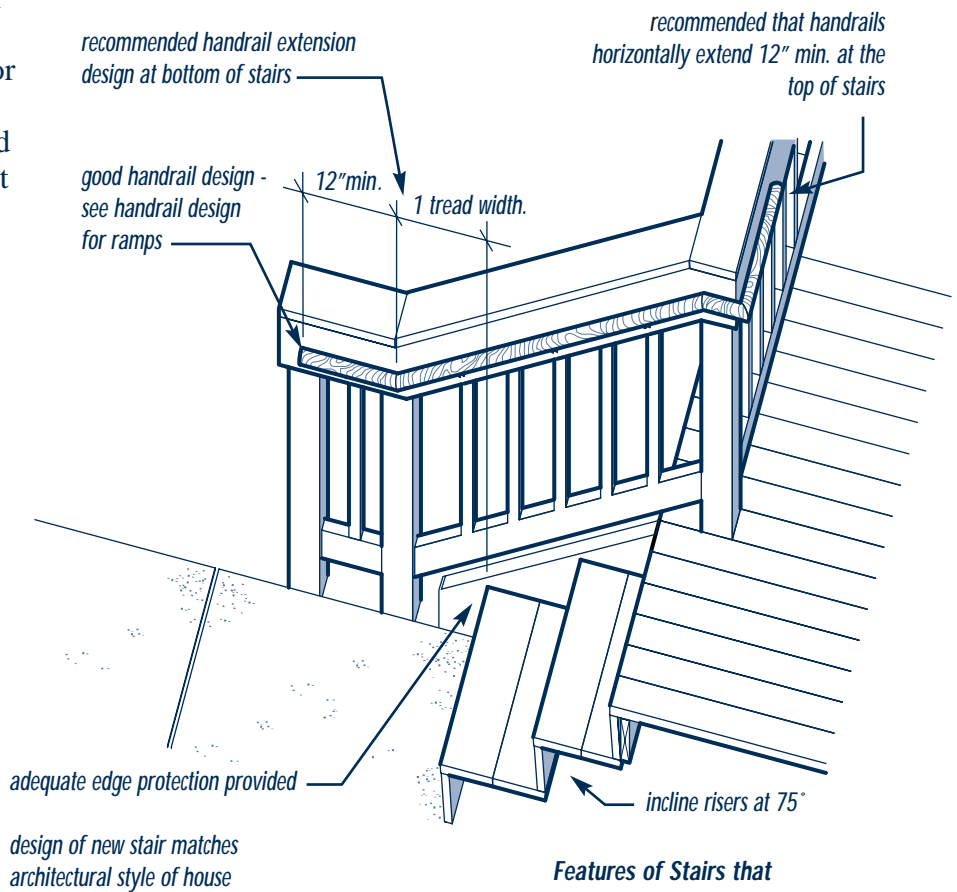

Features of Stairs that Improve Usability

Costs

Whether you build it yourself or contract with a carpenter or remodeler, total project costs may extend beyond just the ramp expenses. Additional project costs may include rebuilding a porch to raise its level to that of the first floor, adding new stairs or new railings, adding a walkway, shrubbery, or adding a wider front door.

Costs for a contracted ramp, excluding other project costs, can vary from \$100 to \$200 per running foot or \$1,200 to \$2,400 per vertical foot. At these rates, a sixteen-foot long ramp will cost \$1,600 to \$3,200. These costs could go down if you use donated materials or labor. The expenses for the related project items, listed above, need to be added on to any overall project budget.

Materials

Pressure treated lumber that resists rot and decay has become the standard for most exterior wood projects. Until recently, local lumber dealers have been able to supply at least two levels of treatment with two price levels: ground contact (.40 rating) or non-ground contact (.25 rating). New regulations have changed the type and availability of pressure treated lumber (what used to be known as salt treated, CCA [copper chromated arsenic] treated, or Osmose® lumber). Check with your lumber supplier for the current status of the old and new rot resistance treatments.

It has become commonplace to use nominal, 2" thick decking (2" x 4", 2" x 6", or 2" x 8") on porches, stairs, decks, and ramps. These boards have the advantage of being sturdy and can reduce the number of joists or stringers that are required. Unfortunately, this size of lumber also has a massive look and feel that is out of proportion to many homes. Ramps using large decking lumber look over-engineered. A good compromise is 5/4" material (such as 5/4" x 6", which is really 1" thick and 5½" wide) that has some of the structural advantages of the larger stock but is scaled more appropriately for homes.

Slip Resistance

Any ramp will become dangerous when wet, or when covered with leaves, ice, or snow. The type of slip resistance that can be incorporated will depend on the selection and installation of construction materials, the ramp finish, and ramp maintenance.

Traditional enamel deck paint is generally too slippery to recommend. It is possible to purchase paint that has slip resistant additives, such as textured particles. You can also buy add-in textured particles for standard deck paint, or you can simply add sand. These rough additives tend to wear away and need to be replenished annually to maintain their slip resistance. Most semi-transparent stains will add color to raw wood without adding a

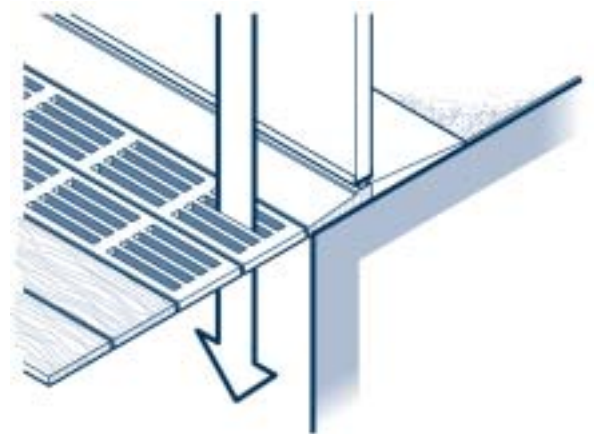

Openings in Decking or Grates Allow Water to Pass Through and Air to Circulate

slippery finish. New manufactured decking products, such as Trex® and TimberTech™, have recently come on the market and, while being more expensive than standard wood products, have the advantage of not requiring finishing and may be more slip resistant.

Limiting the amount of snow, water and ice build up is a good way to avoid slipping hazards. While it is usually impractical to roof an entire ramp, use existing porch roofs as much as possible or consider adding a porch roof or awning if none is present.

Water drainage at doorways can be more of a concern when porches or steps are raised to first floor level. Proper water drainage and increased slip proofing at doorways can be aided by installing slotted decking, grates, or grills, which allows water to drain more quickly and snow and ice to fall through. Care must be taken that slots for drainage are not so large as to impede the wheels of mobility devices. Avoid using plywood, as it creates a solid surface that doesn't allow for drainage.

Code Compliance

Many individuals believe that residential ramps must comply with public building ramp requirements. Building codes and access standards **do not** cover most single-family residential access remodeling.

People incorrectly cite the design requirements of two prominent federal “access codes,” the Americans with Disabilities Act (ADA, 1990), and the Fair Housing Amendments Act (1988). Neither the ADA nor the Fair Housing Act Access Guidelines apply to single family remodeling. In fact, a ramp built onto a house in accordance with ADA or Fair Housing Guidelines would be much larger than necessary or would have restrictive handrail configurations. For example, many believe that residential ramps need to follow federal codes and build ramps that are 4' wide. Ramps of this size are out of scale with most houses. While some people might find this helpful for maneuvering, many ramps only need to be 36" to 42" wide. This width is particularly useful for some manual wheelchair user who want to grip handrails on both sides of a ramp at the same time. The solution most appropriate for a particular household should be used instead of a configuration intended for generic public situations. In the context of housing rehabilitation, national accessibility codes and standards should be restricted to the role of providing good general guidance information but not compliance requirements.

Some limited code compliance obligations for single-family homes may come from the state and local level. Many states have their own “access codes” that direct design decisions for public buildings and multi-family housing. These codes generally have a portion that addresses the design of accessible building elements, including ramps. *These codes and guidelines usually do not apply to most single family home remodeling.* However, some state codes do cover ramps on single-family homes but to a lesser extent than their public or multi-family counterparts. Key requirements may cover maximum ramp slope, minimum width, and landing sizes. Most of these codes also address non-accessibility issues of deck or porch construction such as structural and footing requirements, guardrail limitations, or other matters in small-scale residential projects. What to do? Closely question your remodeler or local inspection or planning office and refer to the design guidelines that are listed here.

In addition, ramps, as with all construction projects, usually need to stay within the locally determined set back, which is the distance from the lot line beyond which construction cannot take place.

Resource Publications

Accessible Housing Design File

Barrier Free Environments, Inc., Van Nostrand Reinhold, 1991, 213 pp.,
\$52.95 + state sales tax
ISBN 0-442-00775-2

Available from:

John Wiley & Sons
Consumer Accts.
10475 Crosspoint
Indianapolis, IN 46256
1-877-762-2974

Residential Remodeling and Universal Design Making Homes More Comfortable and Accessible

NAHB Research Center and Barrier Free Environments, Inc., U.S. Department of Housing and Urban Development, 1996, 114 pp., \$5.00

Available from:

HUD USER (Pub# HUD-1604-PDR)
P.O. Box 6091
Rockville, MD 20849
800-245-2691

How to Build Ramps for Home Accessibility

Metropolitan Center for Independent Living, Inc., 64 pp.,

Available from:

Metropolitan Center for Independent Living, Inc.
1600 University Avenue West
St. Paul, MN 55104-3825
651-603-2029

Building for a Lifetime: The Design and Construction of Fully Accessible Homes

Margaret Wylde, Adrian Baron-Robins, and Sam Clark, Taunton Press, 1994, 304 pp., \$44.95 + \$4.00 s/h
ISBN 1-56158-036-8

Available from:

The Taunton Press 63 South Main Street
P.O. Box 5506
Newtown, CT 06470-5506
800-888-8286
www.taunton.com

Credits

Project Director/Author

Richard Duncan

Technical Assistance/Content Development

Rex J. Pace

Illustrations

Brian Baker, Rex J. Pace

Graphic Design

Vicky Earp Design

Project Research

Celeste Waid, Michael Carter

Reviewers

Andrea Gabriel, Louis Tenenbaum,
Jayne Yoder, Leslie Young

Funding from the Kate B. Reynolds Charitable Trust, Ability Program, and the National Institute for Disability and Rehabilitation Research



Additional funding was provided by Grant #91557/3 from the Centers for Medicare and Medicaid Services to Delaware Health and Social Services.



The statements and conclusions contained in this booklet are those of the Center for Universal Design. This document is intended to serve as a guide to design professionals and those involved in constructing ramps. The Center for Universal Design has made every effort to verify the accuracy and appropriateness of this booklet's content so it may be regarded as an accurate resource document. Yet, the information is advisory and the guidance provided is not legally binding. Readers are advised to refer to specific codes, regulations, and requirements within their jurisdictions and to remember that no guarantee is offered or implied for the completeness of the information provided.

THE CENTER FOR **UNIVERSAL DESIGN**

NC STATE UNIVERSITY College of Design



Center for Universal Design
College of Design
NC State University
Box 8613
Raleigh, NC 27695-8613

919.515.3082 (V/TTY)
919.515.7330 (FAX)
800.647.6777 (V/TTY Info Request Line)

cud@ncsu.edu

<http://www.design.ncsu.edu/cud>

© Copyright 2004 North Carolina State University, Center for Universal Design